

A

B

C

D

3-2. SCHEMATIC DIAGRAM

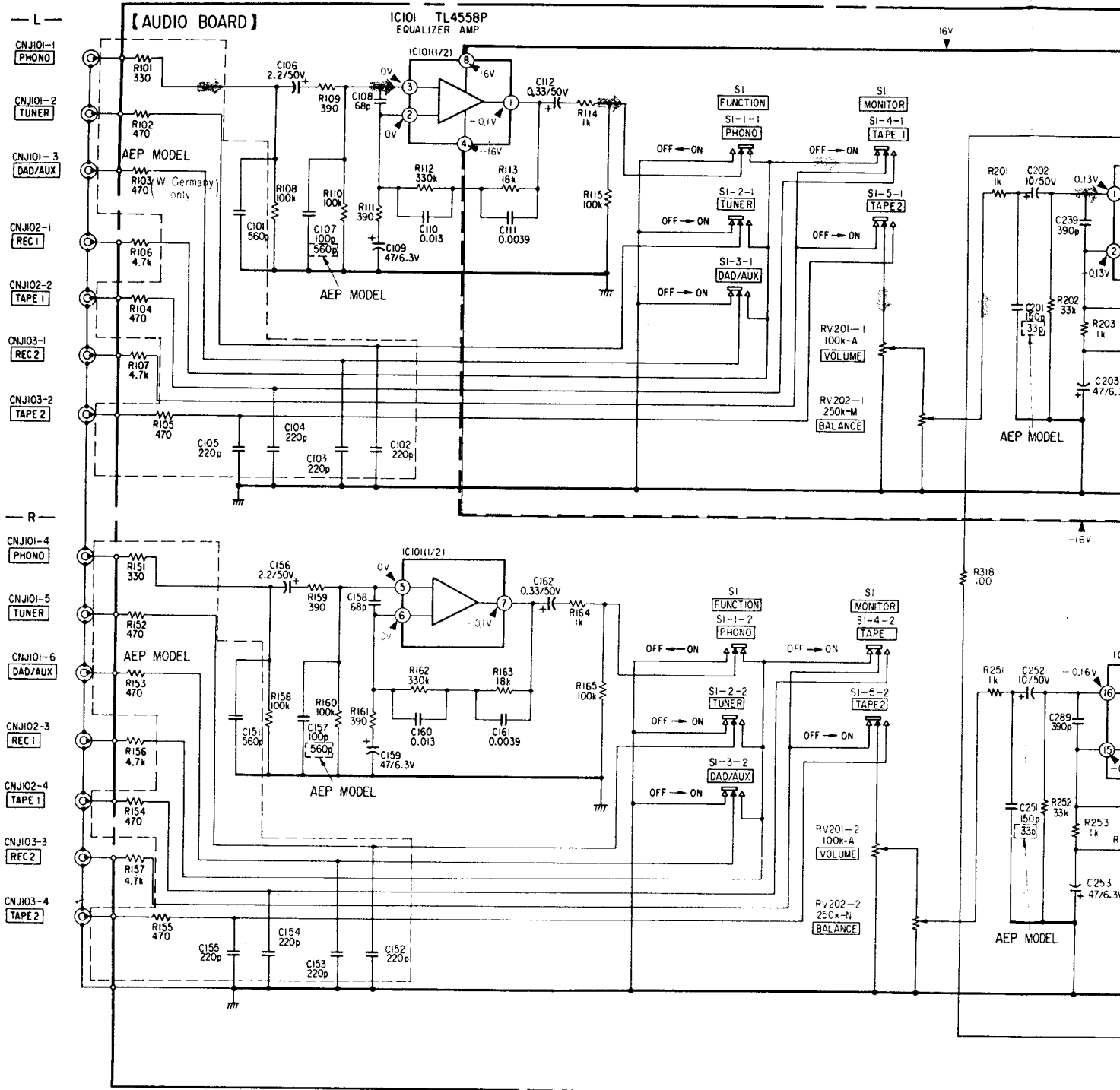

INTEGRATED - STEREO AMPLIFIER,  
SONY TA-AX22

[TONE BOARD(1/3)]

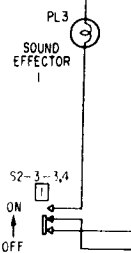

IC201 STK3041  
POWER DRIVE AMP

IC202 STK2129  
POWER AMP

Q202, 203, 204 2SC2021  
SOUND EFFECTOR DRIVE

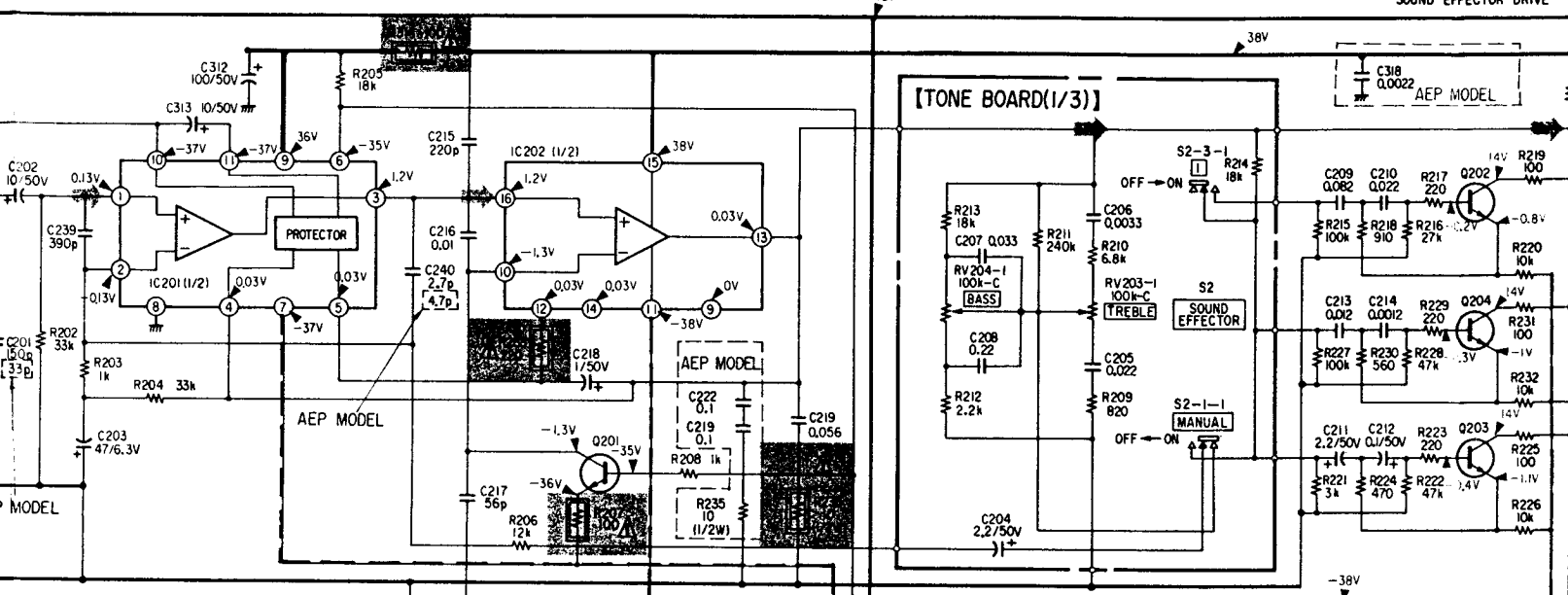

Q201 2SC1890  
CURRENT REG

Q252, 253, 254 2SC2021  
SOUND EFFECTOR DRIVE

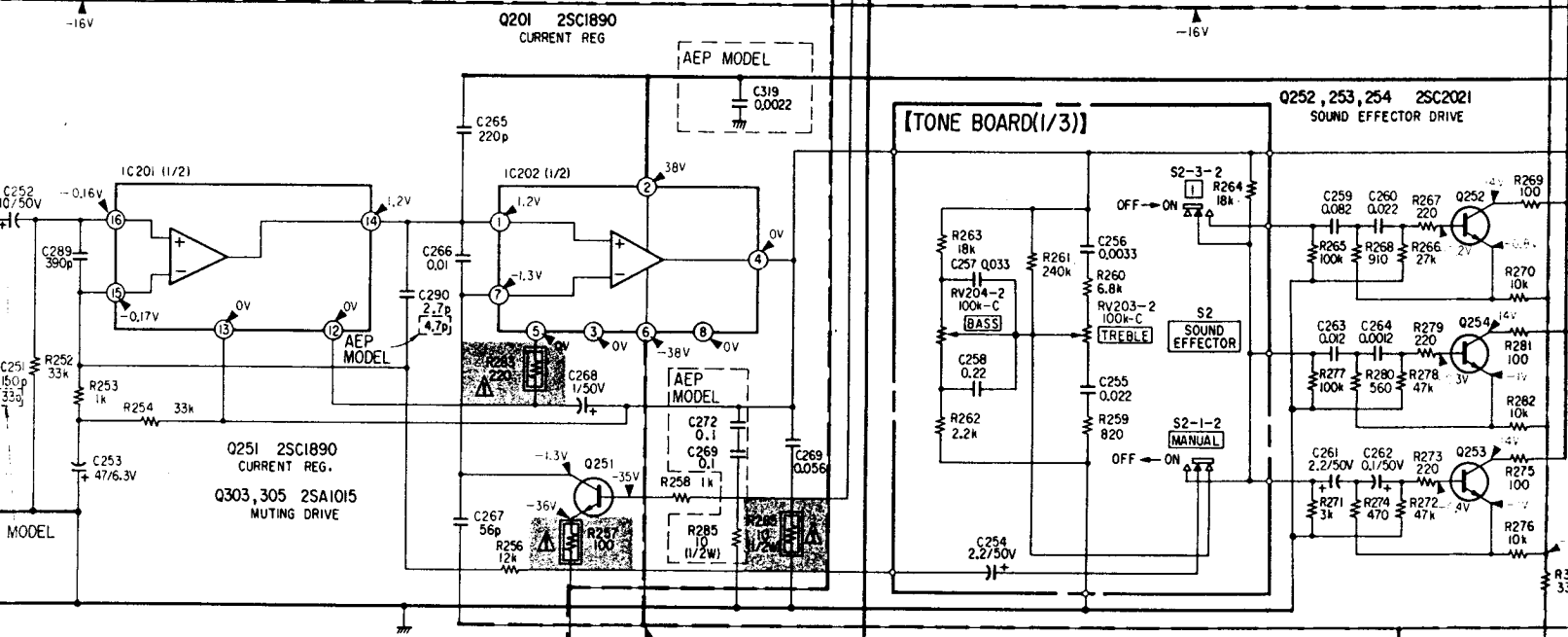

Q251 2SC1890  
CURRENT REG.  
Q303, 305 2SA1015  
MUTING DRIVE

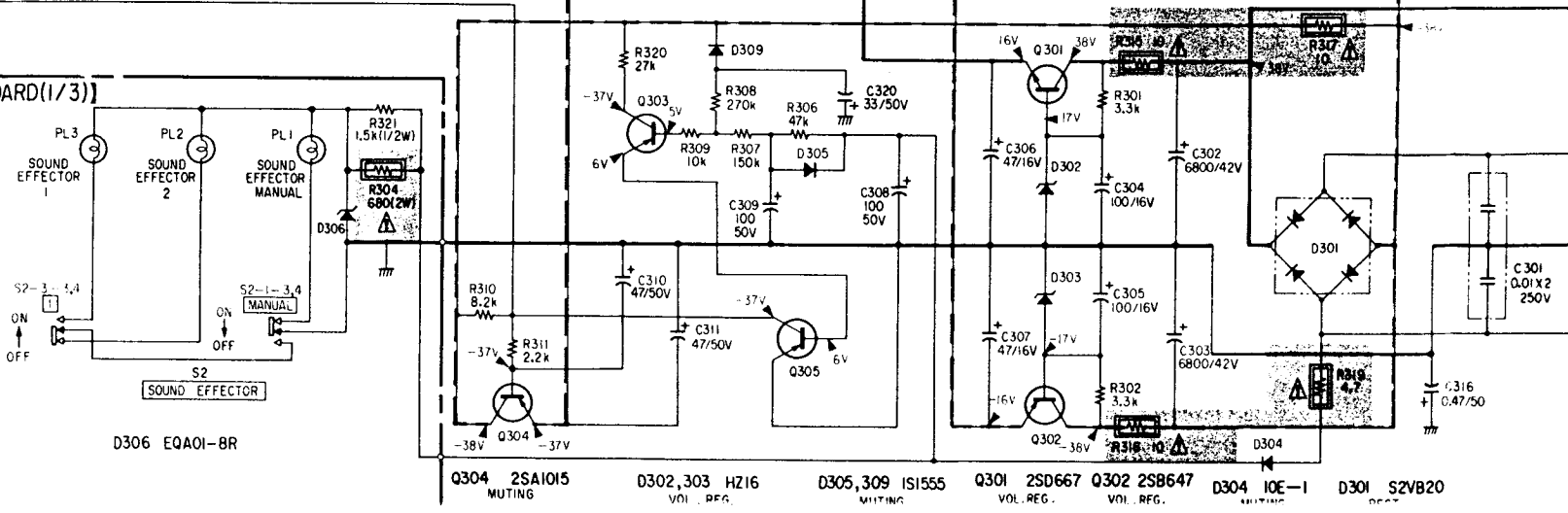

Q202, 203, 204 2SC2021  
SOUND EFFECTOR DRIVE

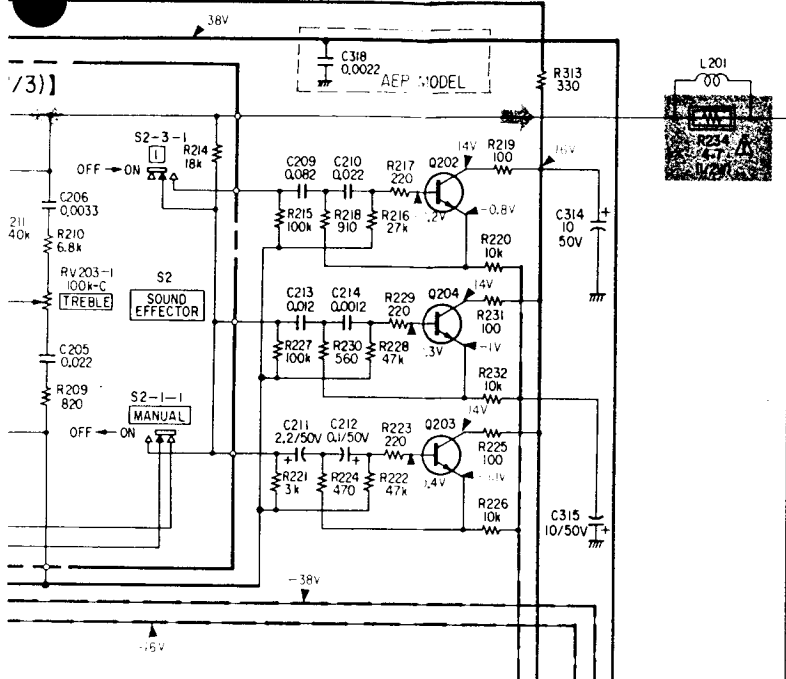

[SPEAKER SW BOARD]

[SPEAKER BOARD]

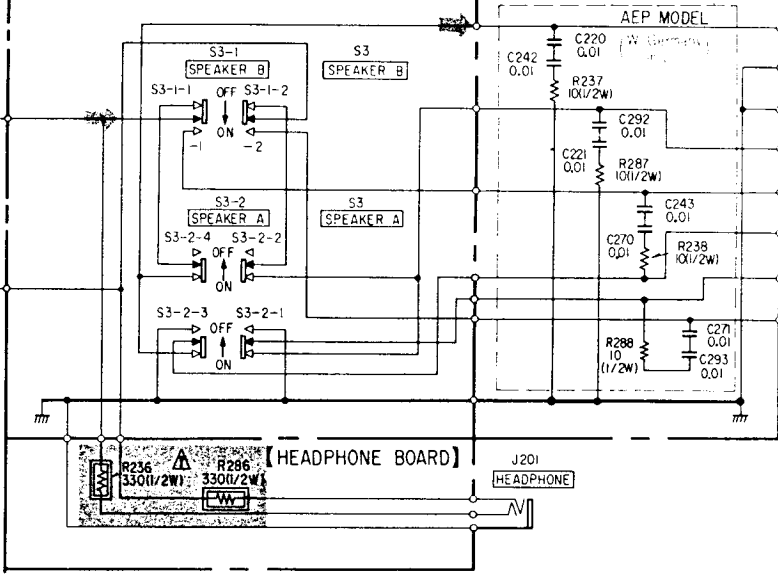

[HEADPHONE BOARD]

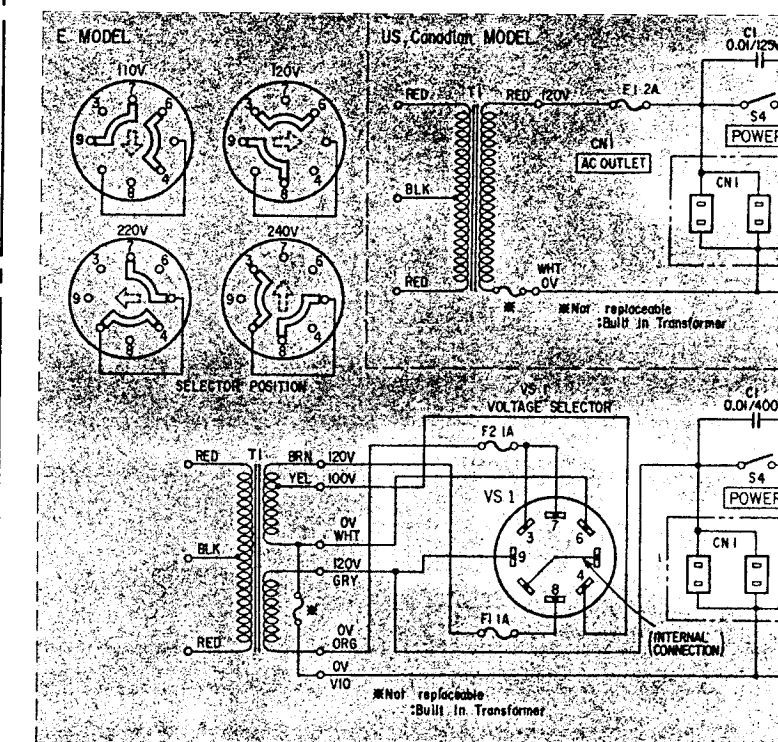

Q252, 253, 254 2SC2021  
SOUND EFFECTOR DRIVE

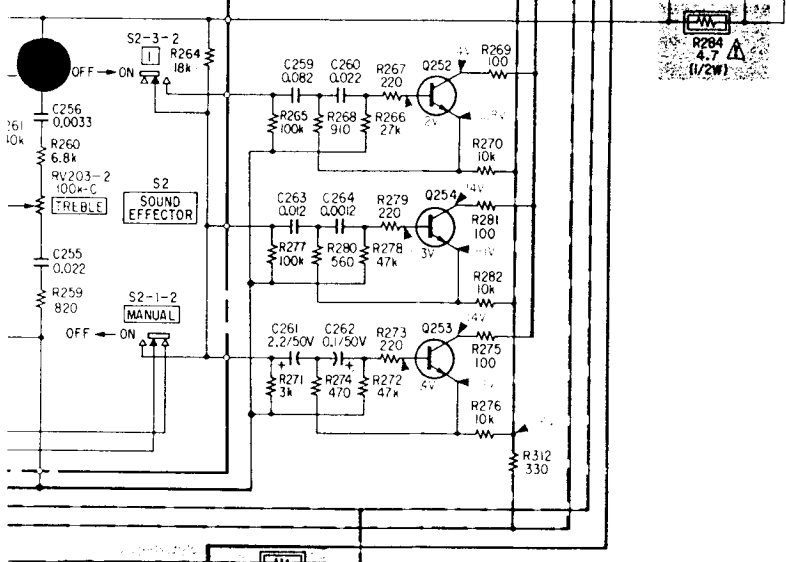

L

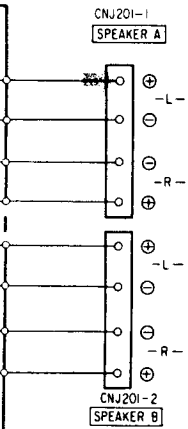





1

**Note:** Les composants identifiés par une trame et une marque  sont critiques pour la sécurité. Ne les remplacer que par une pièce portant le numéro spécifié.

**Note:** The components identified by shading and mark  are critical for safety. Replace only with part number specified.

**Note:**

- All capacitors are in  $\mu\text{F}$  unless otherwise noted.  $\text{pF}$  :  $\mu\mu\text{F}$  50WV or less are not indicated except for electrolytics and tantalums.
- All resistors are in ohms,  $\frac{1}{4}\text{W}$  unless otherwise noted.  $\text{k}\Omega$  :  $1000\Omega$ ,  $\text{M}\Omega$  :  $1000\text{k}\Omega$
-  : nonflammable resistor.
-  : panel designation.
-  : B+ bus.
-  : B- bus.
- Voltages are dc with respect to ground unless otherwise noted.
- Readings are taken under no-signal conditions with a VOM ( $50\text{k}\Omega/\text{V}$ ).
- Voltage variations may be noted due to normal production tolerances.
-  : signal path

2

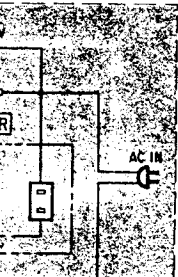

3

• Switch

Ref. No.	Switch	Position
S1-1	PHONO	ON
S1-2	TUNER	OFF
S1-3	DAD/AUX	OFF
S1-4	TAPE 1	OFF
S1-5	TAPE 2	OFF
S2-1	SE MANUAL	ON
S2-3	SE 1	OFF
S3-1	SPEAKER B	OFF
S3-2	SPEAKER A	ON
S4	POWER	OFF

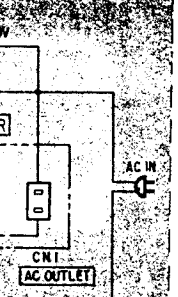

4

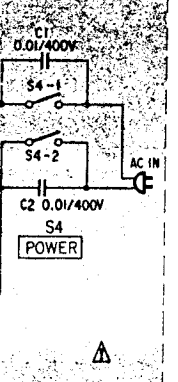

5